

WALL CABINET ASSEMBLY INSTRUCTION

W(24-42)36

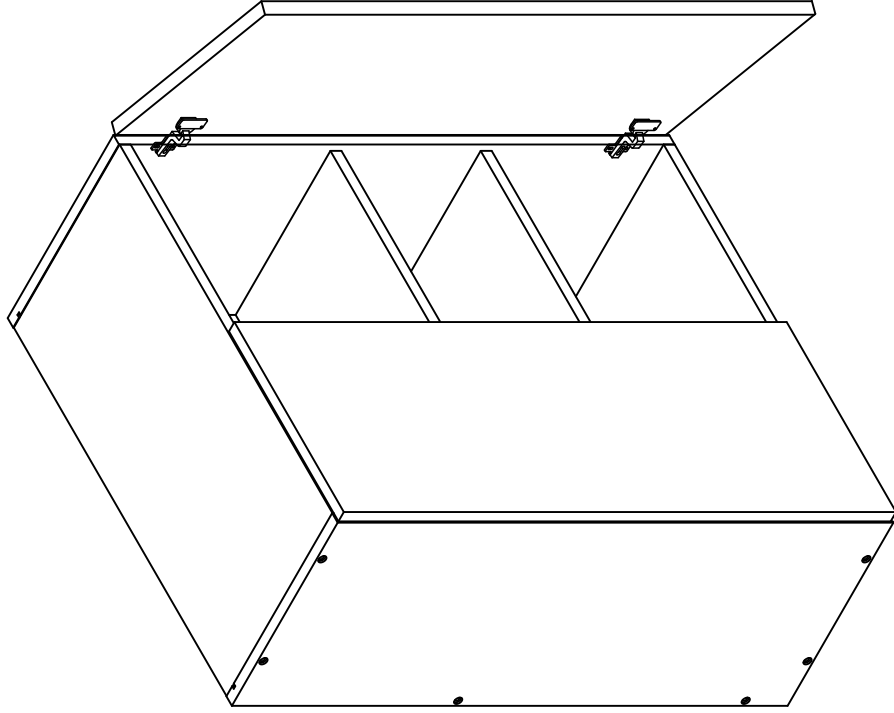





Assembly instructions

Carefully read the Instructions before starting the installation.

During assembly, please follow all generally accepted safety procedures.

If you are missing any part, please stop and contact us immediately at

Hardware Fitting		
Hinge		4PCS
Shelf Support		8PCS
Screws	4*16 	24PCS
Bumper		4PCS
Cabinet Screws	7*50 	14CS

Left Side Panel		1PC
Right Side Panel		1PC
Bottom Panel		1PC
Back Panel		1PC
Support Rail		3set
Top Panel		1PC
Removable Shelf		2PC

Step1

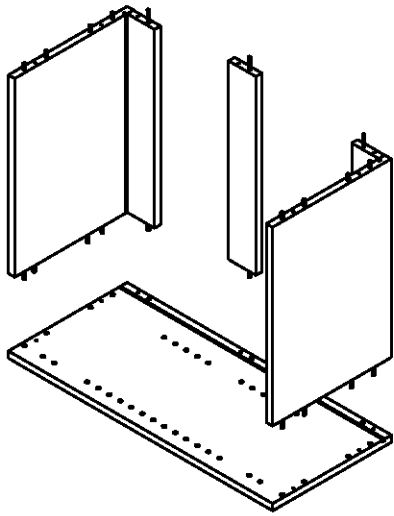

Step2

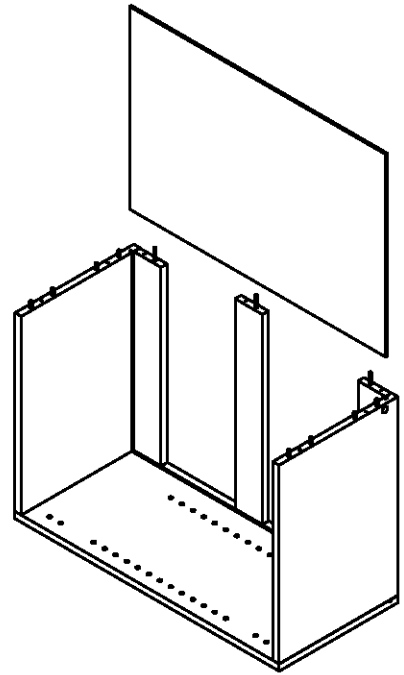

Step3

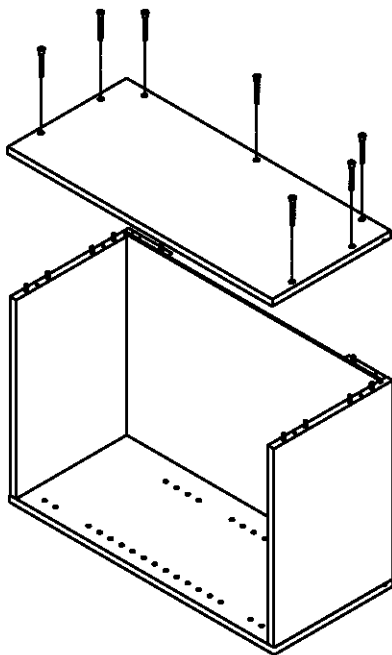

Step4

