

WALL CABINET ASSEMBLY INSTRUCTION

W(24-42)30

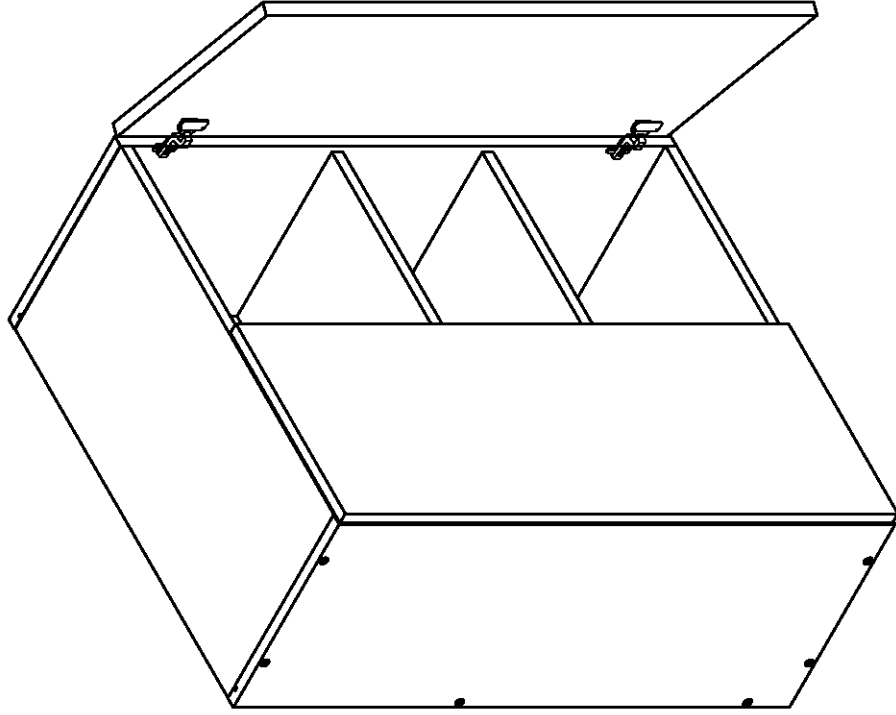





Assembly instructions

Carefully read the Instructions before starting the installation.

During assembly, please follow all generally accepted safety procedures.

If you are missing any part, please stop and contact us immediately at

Hardware Fitting	
Hinge	4PCS 
Shelf Support	8PCS 
Screws	4*16 24PCS 
Bumper	4PCS 
Cabinet Screws	7*50 12CS 

Left Side Panel	1PC
Right Side Panel	1PC
Bottom Panel	1PC
Back Panel	1PC
Support Rail	2set
Top Panel	1PC
Removable Shelf	2PC

Step1

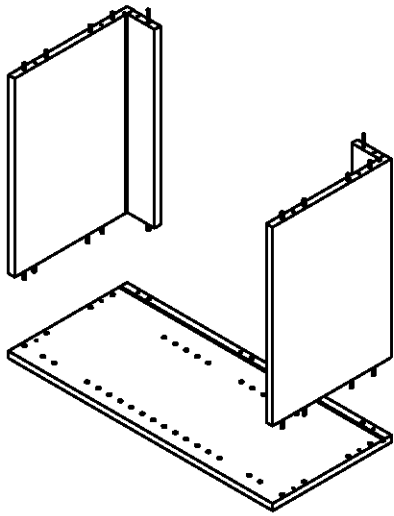

Step2

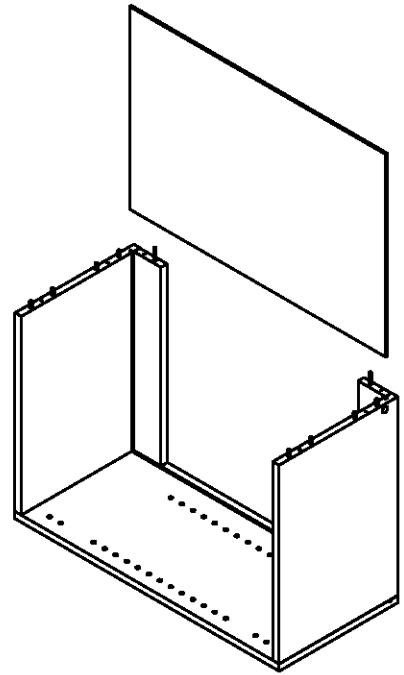

Step3

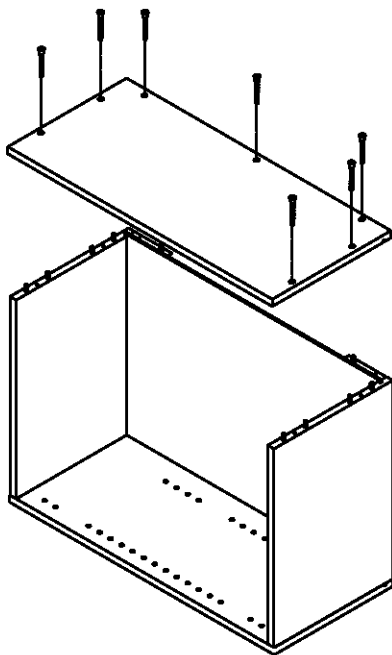

Step4

