

BASE CABINET ASSEMBLY INSTRUCTION

MOC3096

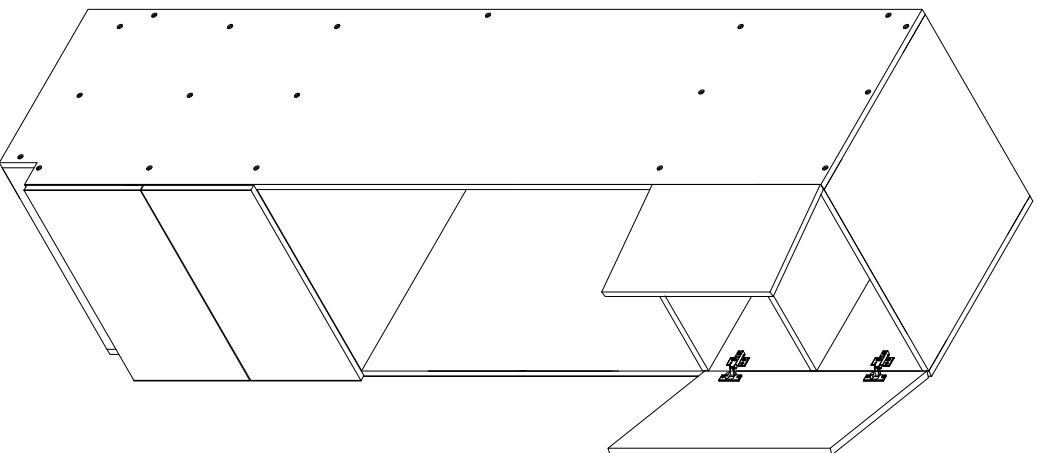

Assembly instructions

Carefully read the Instructions before starting the installation.

During assembly, please follow all generally accepted safety procedures.

If you are missing any part, please stop and contact us immediately at

Hardware Fitting	
Hinge	4PCS
Shelf Support	4PCS
Slide rail	2SET
Slide rail Screws	8PCS
Screws	16PCS
Drawer face Screws	8PCS
Bumper	12PCS
Cabinet Screws	32CS

Left Side Panel	1PC
Right Side Panel	1PC
Top/Bottom Panel	2PC
Back Panel	1PC
Support Rail	3PC
Toe Kick	1PC
Removable Shelf	1PC
Fixed Shelf	2PC
Drawer Side	4PC
Drawer Box Front	2PC
Drawer Box Back	2PC
Drawer Box Bottom	2PC

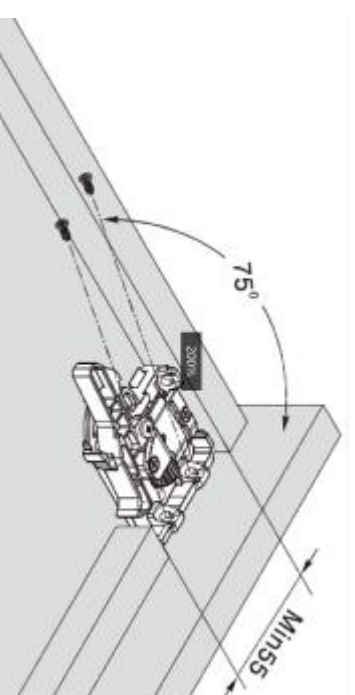

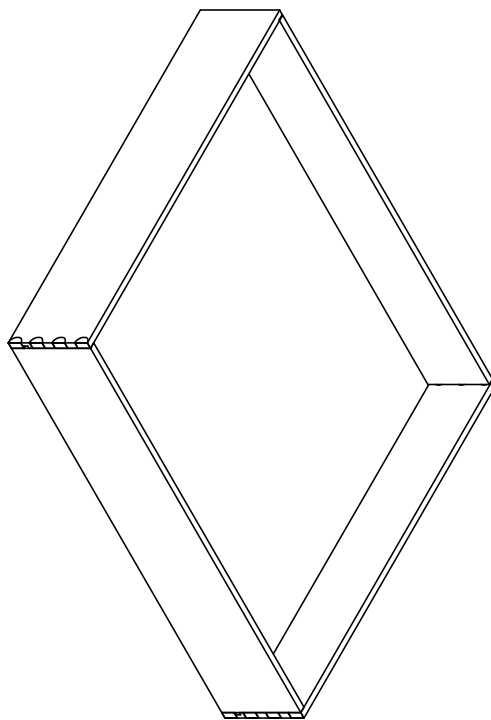
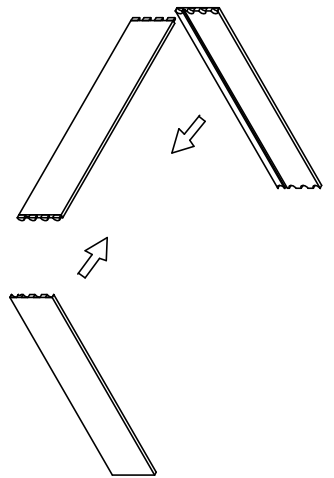
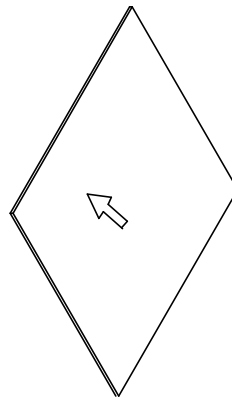
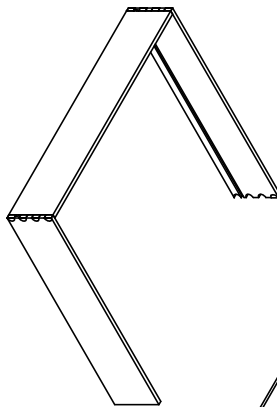
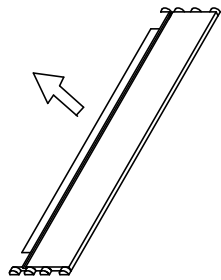
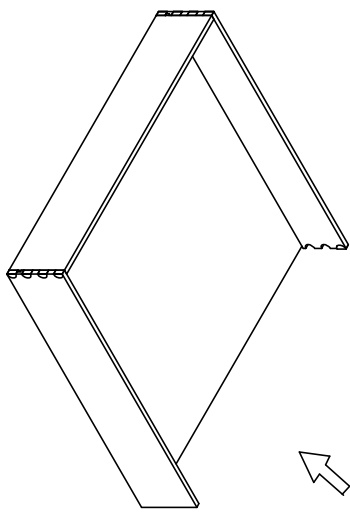

Step 1

Single oven
Double oven

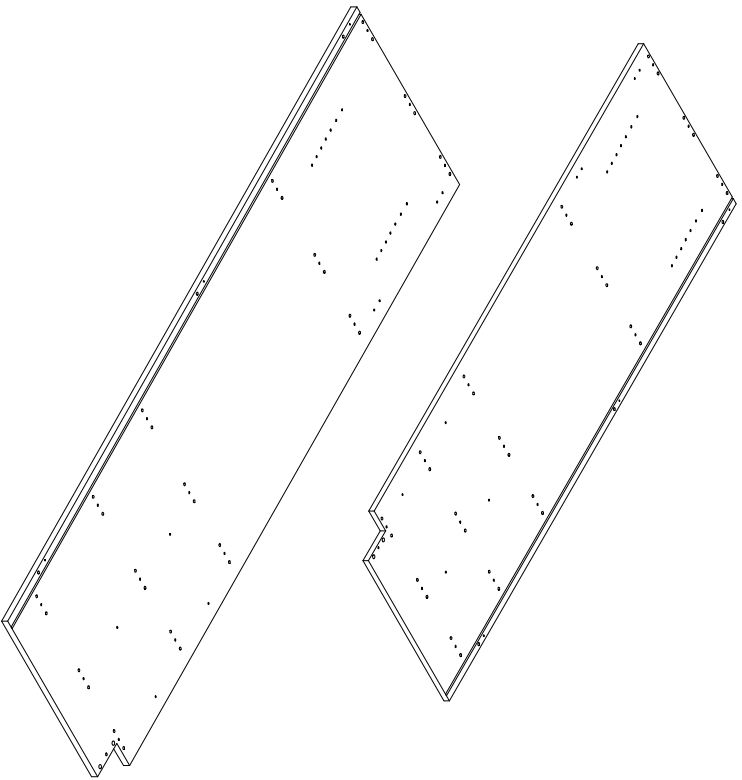

Step 2

Single oven
Double oven

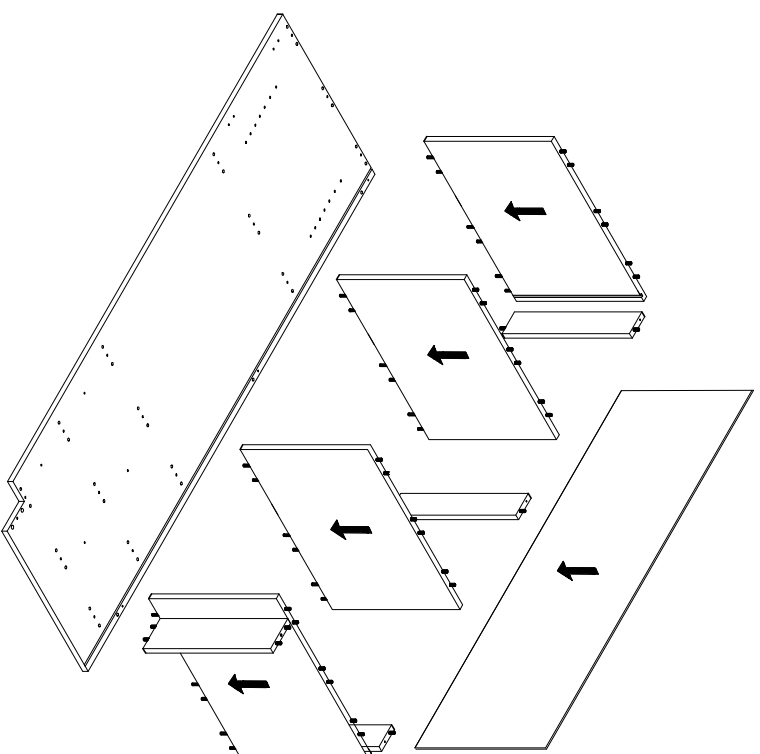

Step 3

Single oven

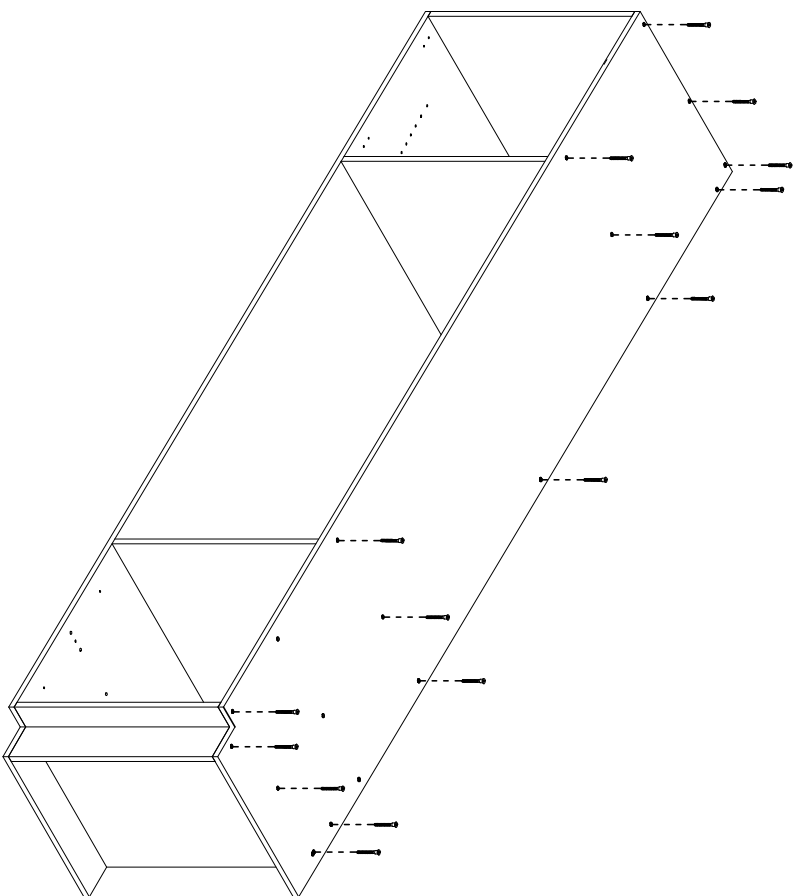

Step 4

Single oven

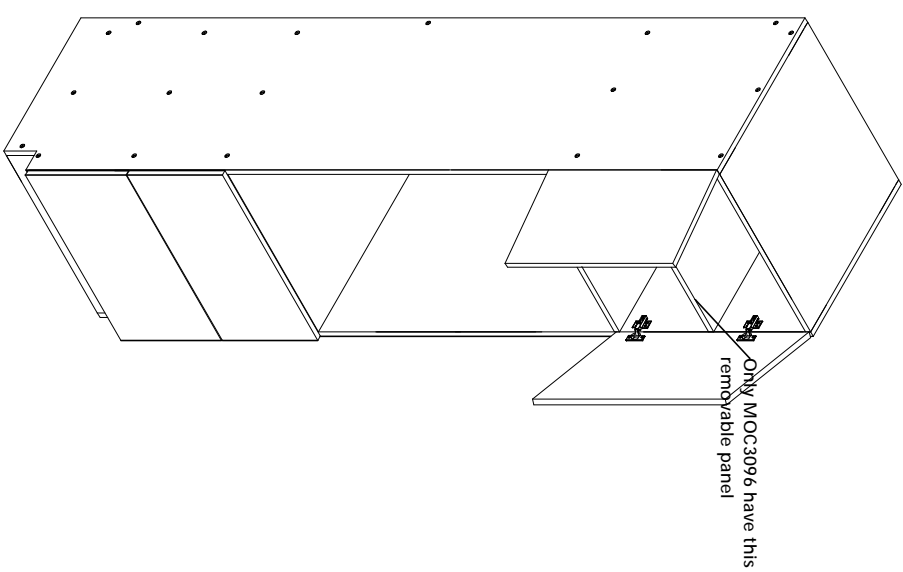

Step 3

Double oven

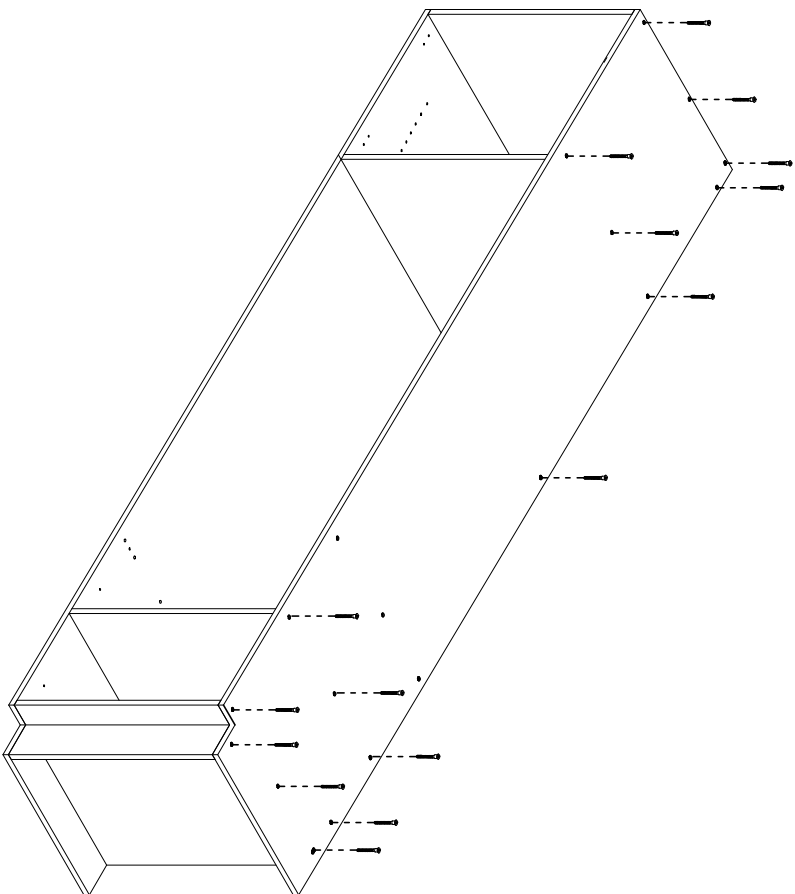

Step 4

Double oven

