

BASE CABINET ASSEMBLY INSTRUCTION

B(09-21)

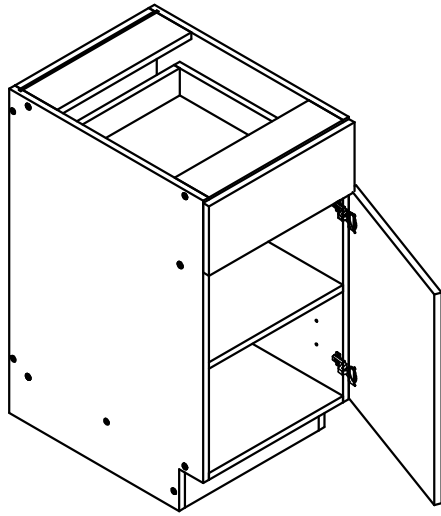

Assembly instructions

Carefully read the Instructions before starting the installation.

During assembly, please follow all generally accepted safety procedures.

If you are missing any part, please stop and contact us immediately at

Hardware Fitting		
Hinge		2PCS
Shelf Support		4PCS
Slide rail		1SET
Slide rail Screws	6*11	4PCS
Screws	4*16	8PCS
Drawer face Screws	4*25	4PCS
Bumper		6PCS
Cabinet Screws	7*50	18CS

Left Side Panel	1PC
Right Side Panel	1PC
Bottom Panel	1PC
Back Panel	1PC
Support Rail	5PC
Toe Kick	1PC
Removable Shelf	1PC
Drawer Side	2PCS
Drawer Box Front	1PC
Drawer Box Back	1PC
Drawer Box Bottom	1PC

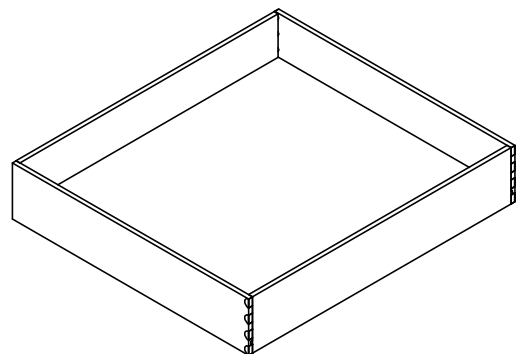
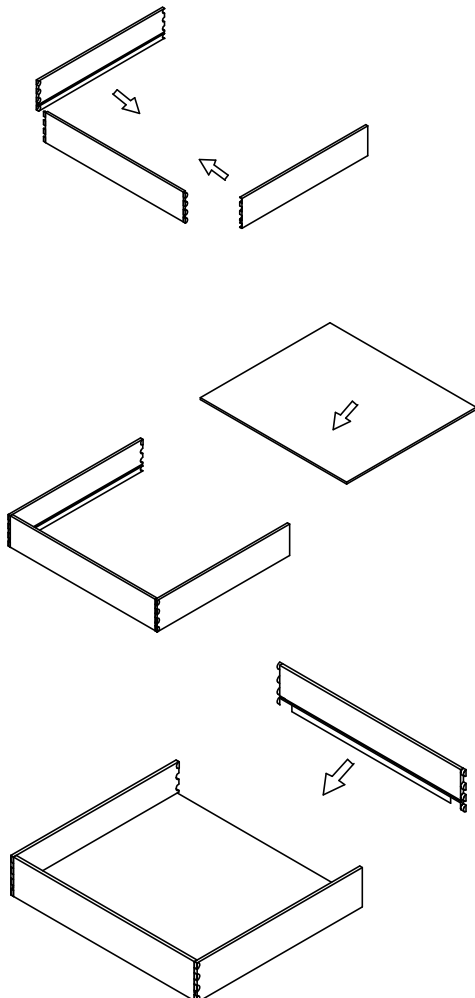
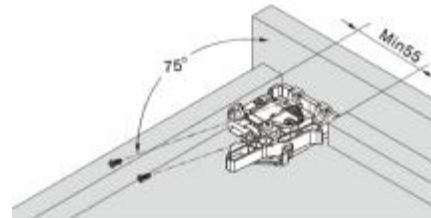

Step1

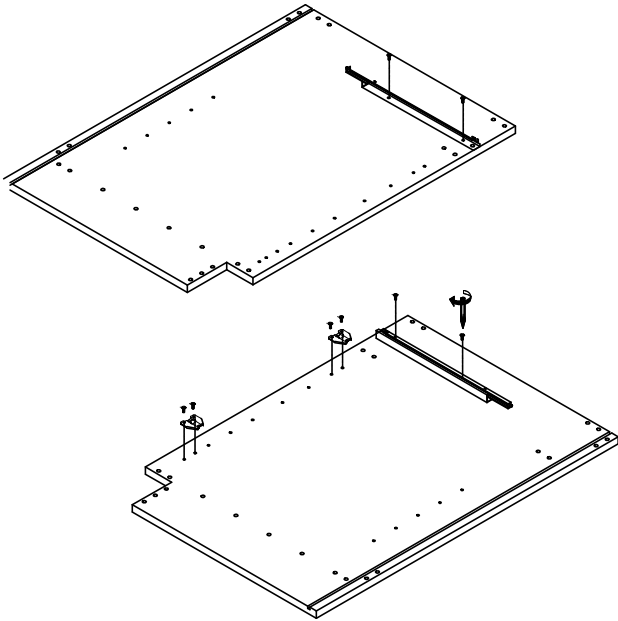

Step2

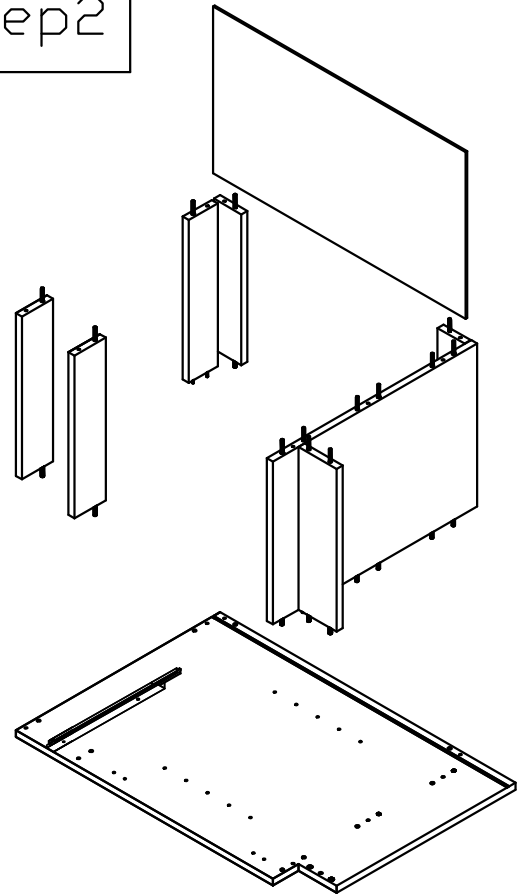

Step3

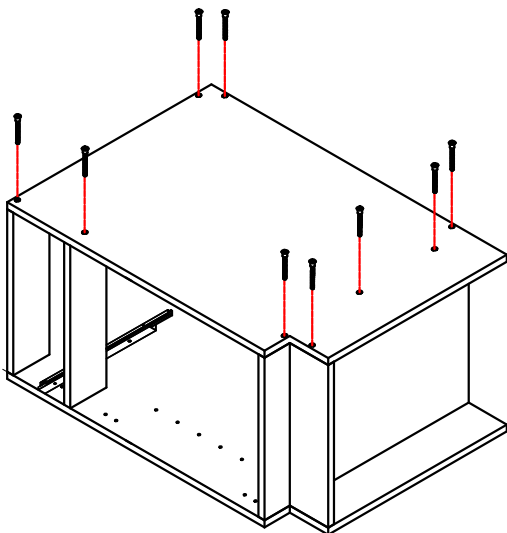

Step4

